

Alle Angaben ohne Gewähr und vorbehaltlich technischer Änderungen und Satzfehler.
All information given are for reference only

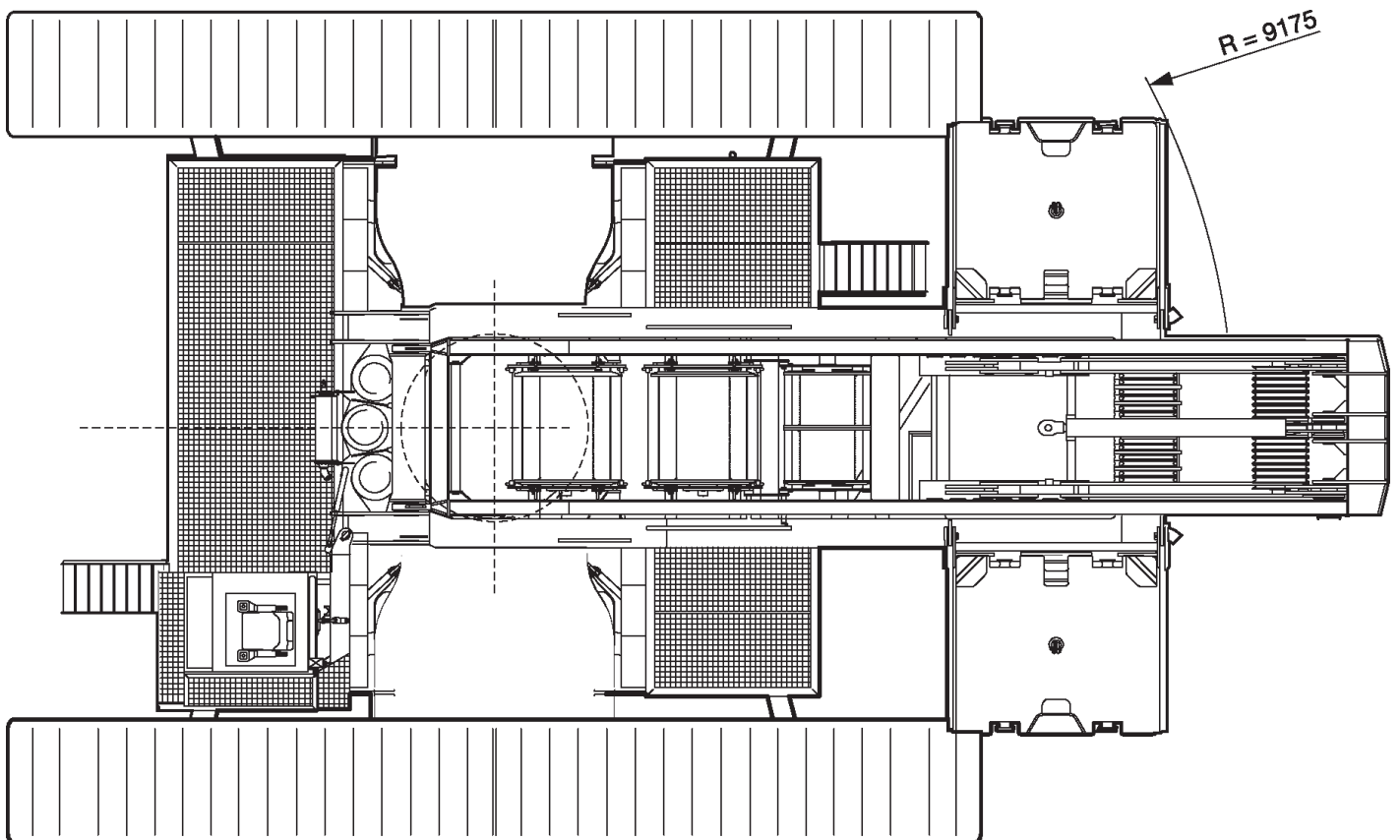

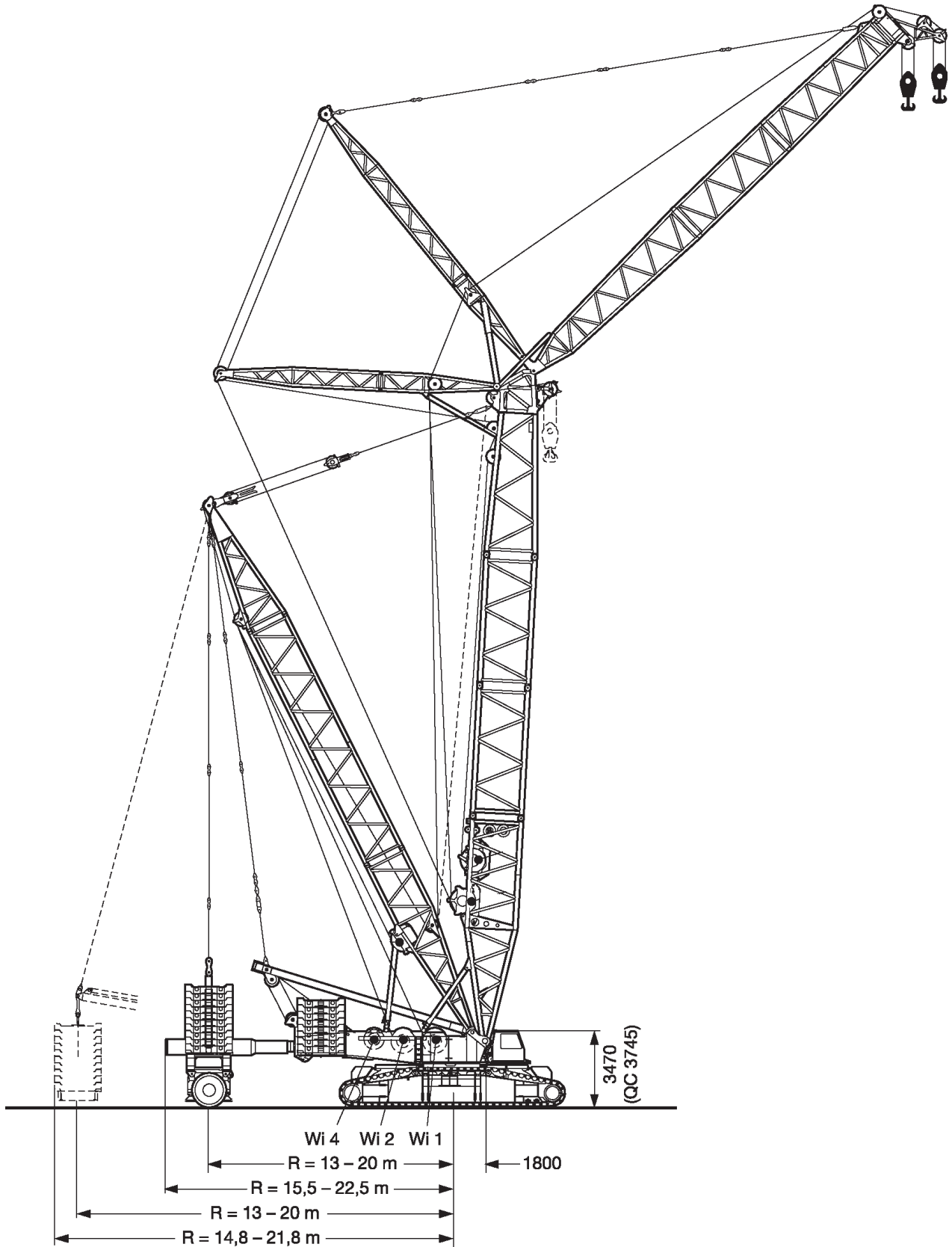

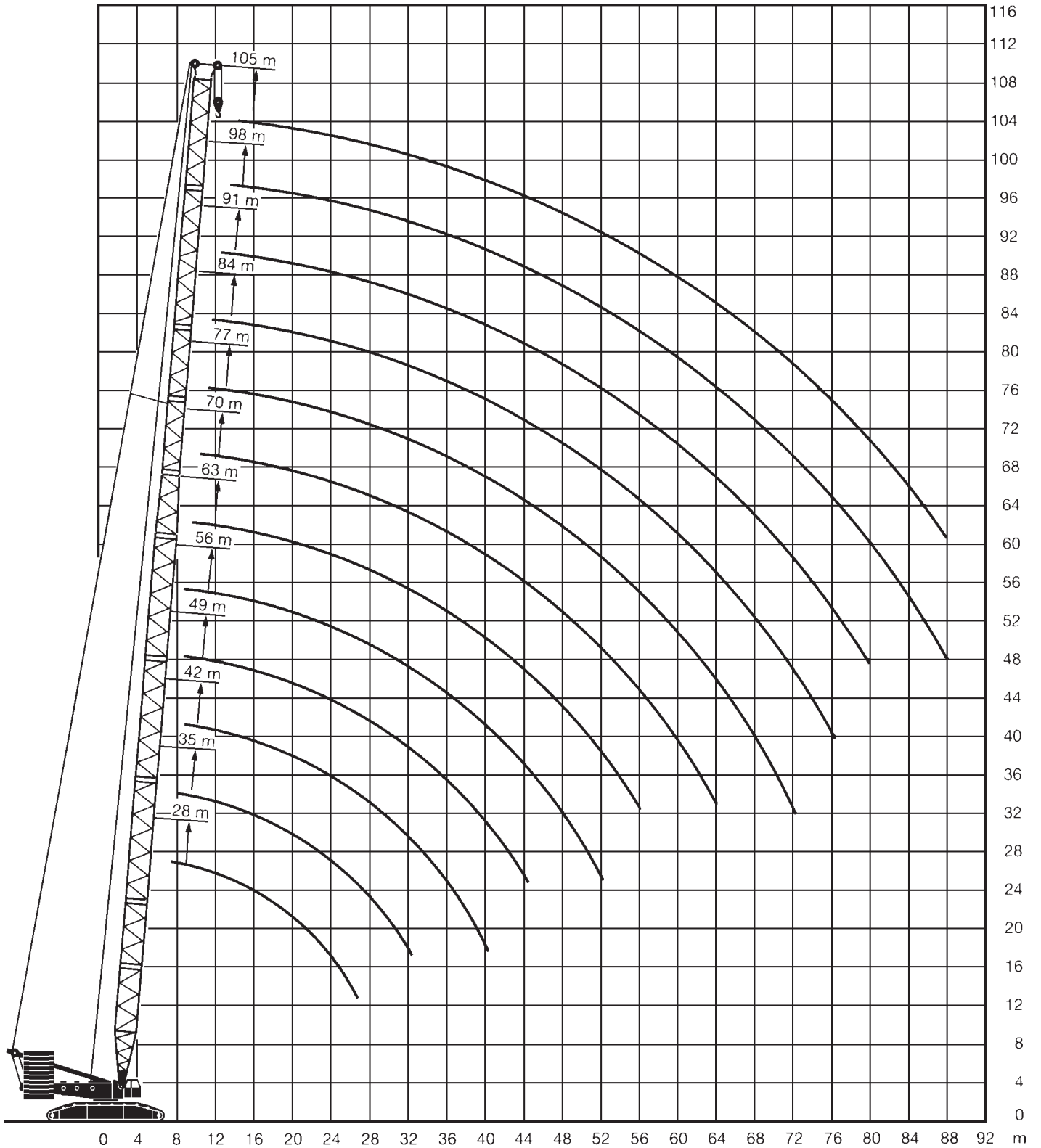

28-105m
SL

8,8m



220/245t



360°



75%

	28	35	42	49	56	63	70	77	84	91	98	105	
6	400												6
6,5	400												6,5
7	400	400											7
8	400	400	400	400									8
9	400	400	400	400	385	366							9
10	400	400	394	390	371	349	329	285					10
11	376	374	373	356	336	316	299	280	270				11
12	345	343	342	323	306	289	274	261	248	214	202		12
14	292	291	288	272	258	246	234	224	213	205	195	161	14
16	252	250	247	234	223	212	203	195	186	179	170	157	16
18	216	216	215	205	195	186	178	172	164	158	151	147	18
20	186	185	185	181	173	166	158	153	146	141	134	131	20
22	163	162	162	160	155	148	142	137	131	127	120	118	22
24	145	144	143	142	140	134	128	124	118	115	109	106	24
26	130	129	128	126	125	122	116	112	107	104	99	96	26
28		116	116	114	113	111	106	102	98	95	90	88	28
30		106	105	103	102	100	97	94	89	87	82	80	30
32		97	96	94	93	91	90	86	82	80	75	73	32
34			88	87	85	83	82	80	75	73	69	67	34
36			82	80	78	77	75	74	70	67	63	62	36
38			76	74	72	71	69	68	64	62	58	57	38
40			71	69	67	65	64	63	60	58	54	52	40
44				60	58	56	55	54	51	49,5	45,5	44,5	44
48					51	49	47,5	46,5	44,5	43	39	38	48
52					45	43	41,5	40	38,5	37	33,5	32,5	52
56						38	36	35	33	32	28,5	27,6	56
60							32	30,5	28,2	27,6	24,3	23,4	60
64							28	26,6	24,2	23,6	20,7	19,7	64
68								23,2	20,7	20	17,4	16,4	68
72								20,3	17,7	17	14,5	13,5	72
76									15,2	14,3	11,8	10,5	76
80										11,9	9,1	7,4	80
84											6,8	5,6	84
88											5,4	4	88

mit 95t Zentralballast

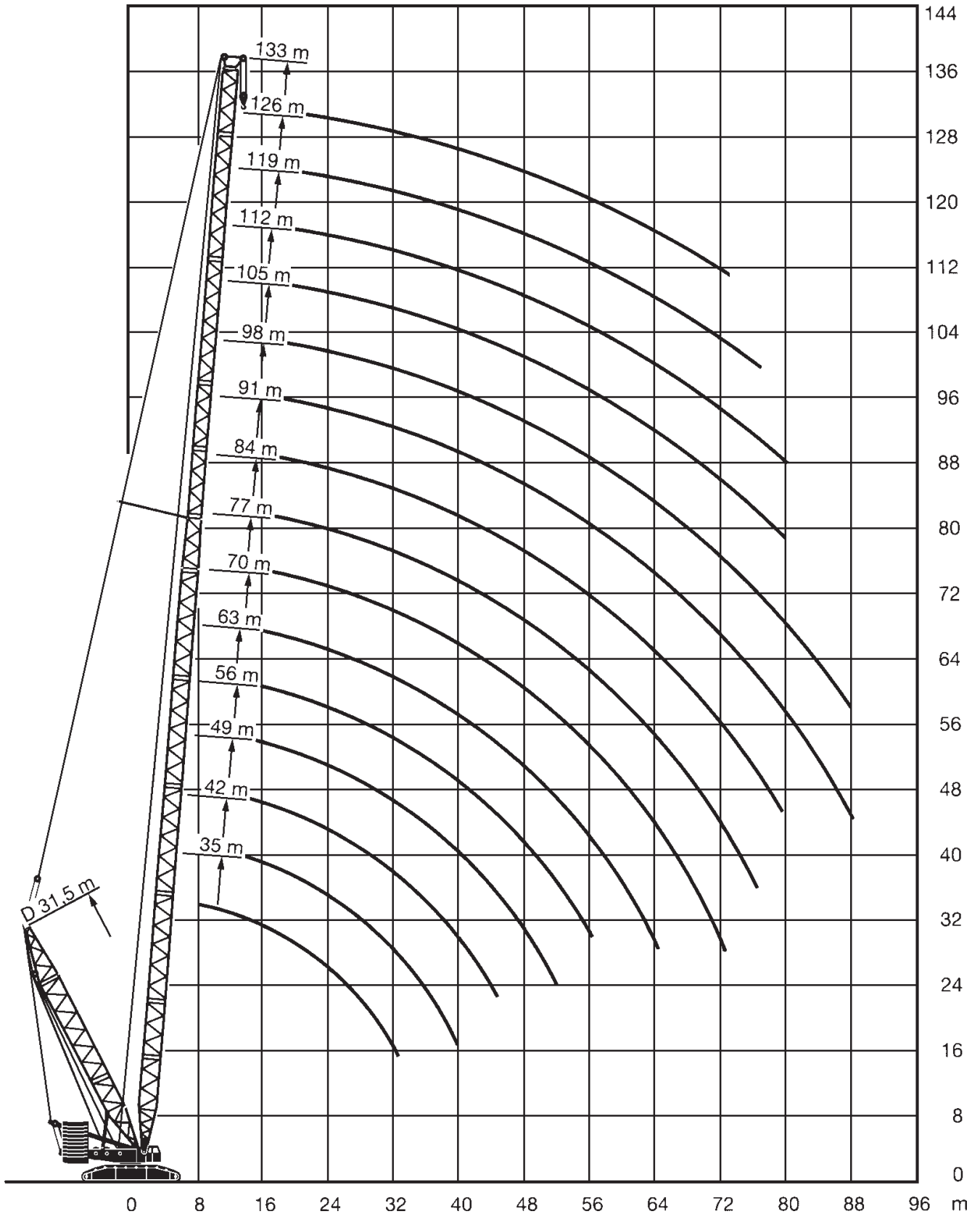

35-133m
SLD

31,5m



8,8m



220/245t



360°



75%

	35	42	49	56	63	70	77	84*	91*	98*	105*	112*	119*	126*	133*	
8			329													8
9		325	325	321												9
10	330	321	322	319	321	332										10
11	325	317	319	317	304	309	294	278								11
12	321	314	312	294	296	283	270	255	245	222						12
14	279	262	256	260	254	241	231	219	212	202	181	162	132			14
16	227	221	220	214	211	209	201	191	186	176	171	161	131	118	100	16
18	195	192	189	187	183	178	177	168	164	156	152	144	130	118	100	18
20	174	170	165	163	159	156	154	150	146	139	135	129	125	117	100	20
22	155	151	147	143	141	137	137	134	132	125	122	116	112	108	100	22
24	137	133	131	128	125	123	121	118	119	113	110	104	101	97	93	24
26	123	121	120	116	114	110	109	105	106	102	100	95	92	88	84	26
28	115	110	109	107	105	100	98	95	95	92	91	86	84	80	76	28
30	107	100	100	99	97	93	89	86	86	82	83	78	76	73	70	30
32	99	94	91	91	90	86	83	77	78	76	75	71	70	66	63	32
34		89	83	83	83	79	77	72	72	70	67	64	63	61	58	34
36		83	78	76	76	73	71	67	67	65	61	57	57	55	53	36
38		78	73	69	70	68	66	62	61	60	56	52	52	49,5	48	38
40		73	69	64	64	62	61	58	57	55	51	47,5	46	44,5	43	40
44			62	58	53	52	52	49,5	47,5	45,5	43	39	38	35,5	34	44
48				52	47,5	43	44	41,5	38,5	37	37	33,5	30	27,7	25,2	48
52				46	42,5	38,5	36	34,5	32,5	28,9	30,5	28,1	24,6	20,6	19,5	52
56					38	34,5	32	27,3	27,3	24	25,1	23,4	20,4	17,4	14,7	56
60						30,5	28,2	23,4	22,3	19,4	19,8	19	16,5	14,7	10,1	60
64						26,8	24,9	20,6	19	15,1	14,8	14,8	12,8	12,1	6,4	64
68							21,8	17,9	16,6	12,3	11,5	10,9	9,4	9,8	5,4	68
72							18,8	15,4	14,4	10,6	9,9	7,1	6,2	7,5	4,4	72
76								13	12,3	9	8,4	4,3	4	5,1		76
80									10,2	7,5	7	3,6	3,4			80
84										6,1	5,7					84
88										4,7	4,4					88

mit 95t Zentralballast

* nur aufrechtbar mit Derrickballast

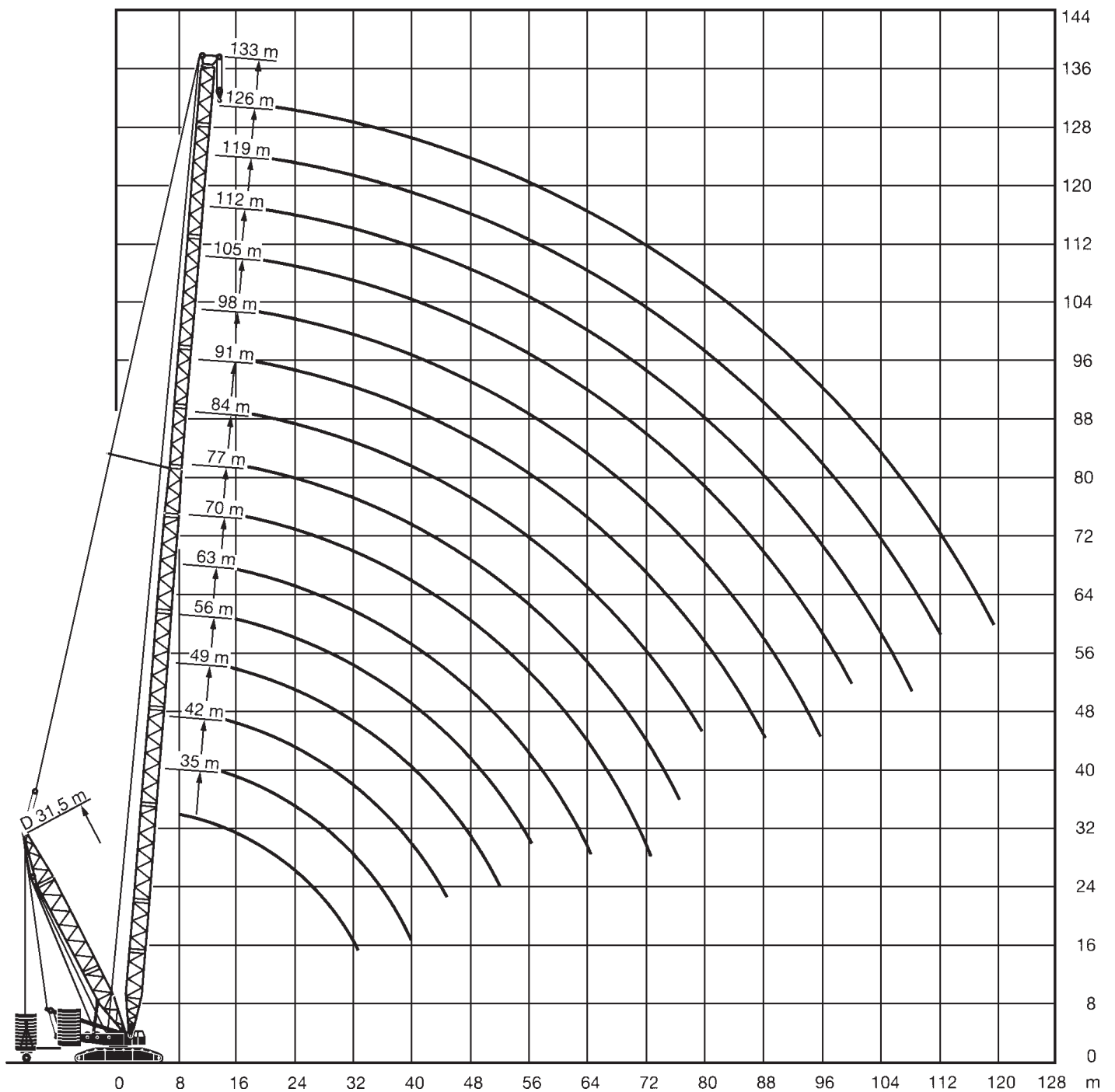

35-133m
SLDB/BW

31,5m



8,8m



170t



400t/20m



360°



75%

	35	42	49	56	63	70	77	84	91	98	105	112	119	126	133	
7	400															7
8	400	400	400													8
9	400	400	400	400												9
10	400	400	400	400	393	371										10
11	400	400	400	400	392	370	328	301								11
12	400	400	400	400	391	370	328	301	245	222						12
14	400	400	400	400	388	368	327	301	244	221	181	162	132			14
16	400	400	400	398	387	367	326	300	243	218	179	161	131	118	100	16
18	400	400	400	396	385	366	326	299	242	216	178	160	130	118	100	18
20	400	400	400	394	384	365	325	289	239	214	176	159	129	117	100	20
22	395	400	395	381	373	361	322	279	230	213	175	158	129	116	100	22
24	357	362	361	357	348	339	311	269	222	207	174	157	128	115	99	24
26	321	335	334	333	328	322	300	260	215	201	172	157	127	115	99	26
28	286	310	309	301	307	306	290	252	208	196	170	156	127	114	98	28
30	254	290	289	288	287	286	280	245	202	191	165	154	126	113	98	30
32	225	267	270	269	268	267	266	237	196	186	160	150	126	113	96	32
34		242	255	254	253	253	253	230	191	182	156	146	125	112	94	34
36		219	242	240	238	236	236	222	186	178	151	142	122	112	92	36
38		198	224	225	223	221	221	213	181	174	147	139	120	110	90	38
40		177	207	212	209	207	207	204	176	170	144	135	117	108	88	40
44			174	189	186	184	184	181	167	162	136	129	113	104	84	44
48				165	168	165	164	162	159	155	130	124	108	100	81	48
52				141	152	149	148	145	146	143	124	119	104	97	77	52
56					134	136	135	132	132	130	118	113	99	93	75	56
60						124	123	120	120	118	113	109	95	90	71	60
64							110	113	110	109	107	104	91	86	68	64
68								104	101	101	97	98	95	87	83	68
72									93	93	93	90	89	87	83	72
76										86	86	83	83	79	79	76
80											78	77	77	74	73	80
84												71	71	68	67	84
88													65	66	63	88
92														60	58	92
96															54	96
100																100
104																104
108																108
112																112
116																116
120																120

mit 45t Zentralballast

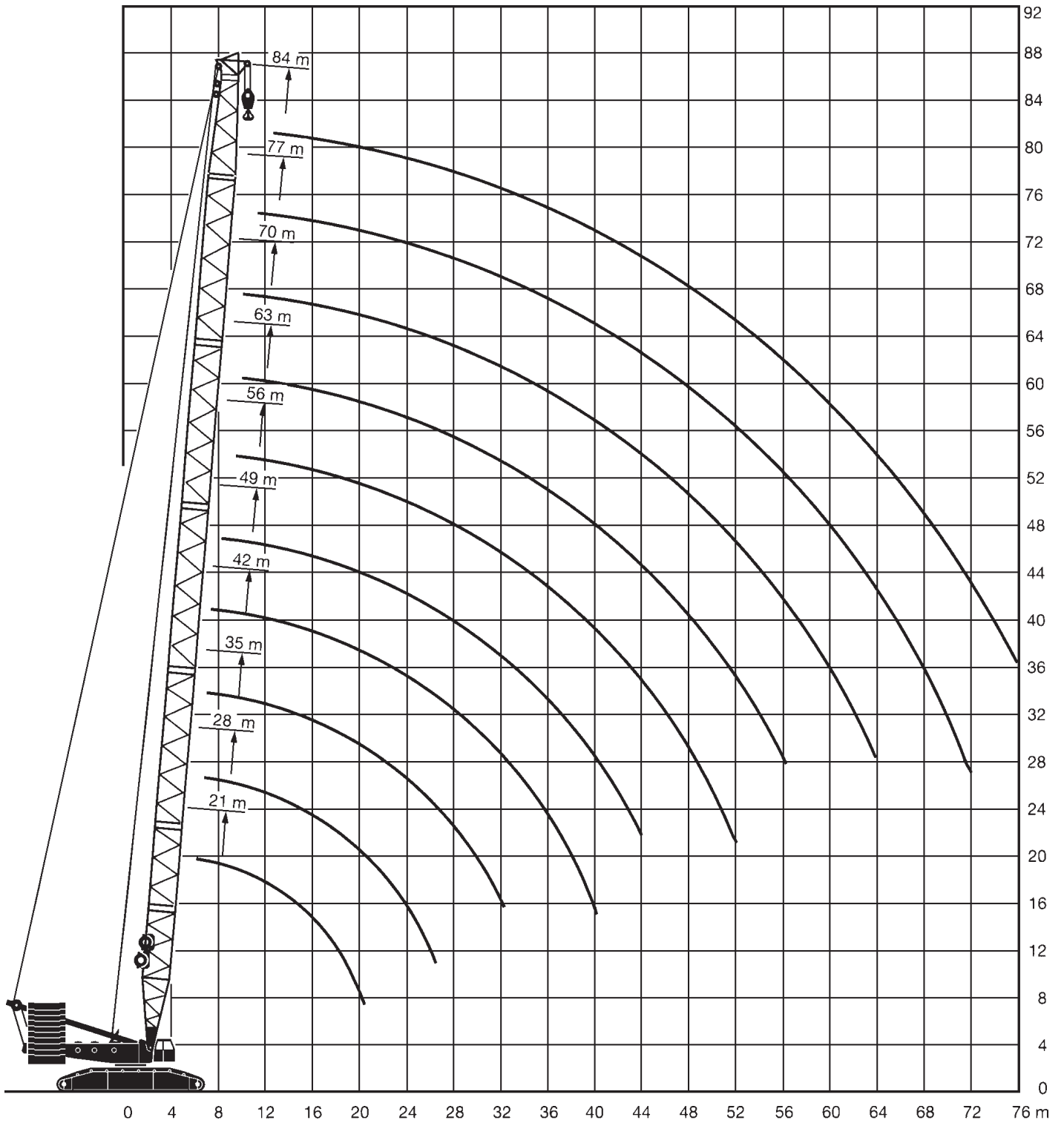

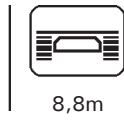
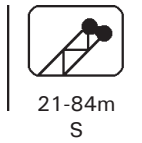

	21	28	35	42	49	56	63	70	77	84	
6	600										6
6,5	600	600									6,5
7	576	574	570								7
8	507	505	505	503	496						8
9	442	453	450	448	434	403					9
10	399	408	405	403	385	360	339	319			10
11	373	371	368	366	346	324	306	289	274	261	11
12	342	340	337	334	313	294	279	264	251	239	12
14	289	287	285	278	261	247	235	223	213	204	14
16	248	246	244	237	223	212	202	192	184	176	16
18	212	211	210	205	194	184	176	168	161	154	18
20	181	181	180	178	171	162	155	148	142	136	20
22		158	156	155	152	144	138	132	126	121	22
24		140	138	136	134	129	123	118	113	108	24
26		125	123	121	119	116	111	106	102	97	26
28			111	109	107	105	101	96	92	88	28
30			100	98	96	94	92	87	83	79	30
32			91	89	87	85	84	79	76	72	32
34				82	79	77	76	72	69	65	34
36				75	73	71	69	66	63	60	36
38				69	67	65	63	61	58	54	38
40				64	62	59	58	56	53	49,5	40
44					53	51	49	47	44,5	41,5	44
48						44	41,5	39,5	37,5	34,5	48
52						38	35,5	33,5	31,5	28,6	52
56							30,5	28	26	23,7	56
60								23,6	21,4	19,4	60
64								19,9	17,5	15,5	64
68									14,2	12,1	68
72									11,5	9,1	72
76										6,6	76

mit 95t Zentralballast

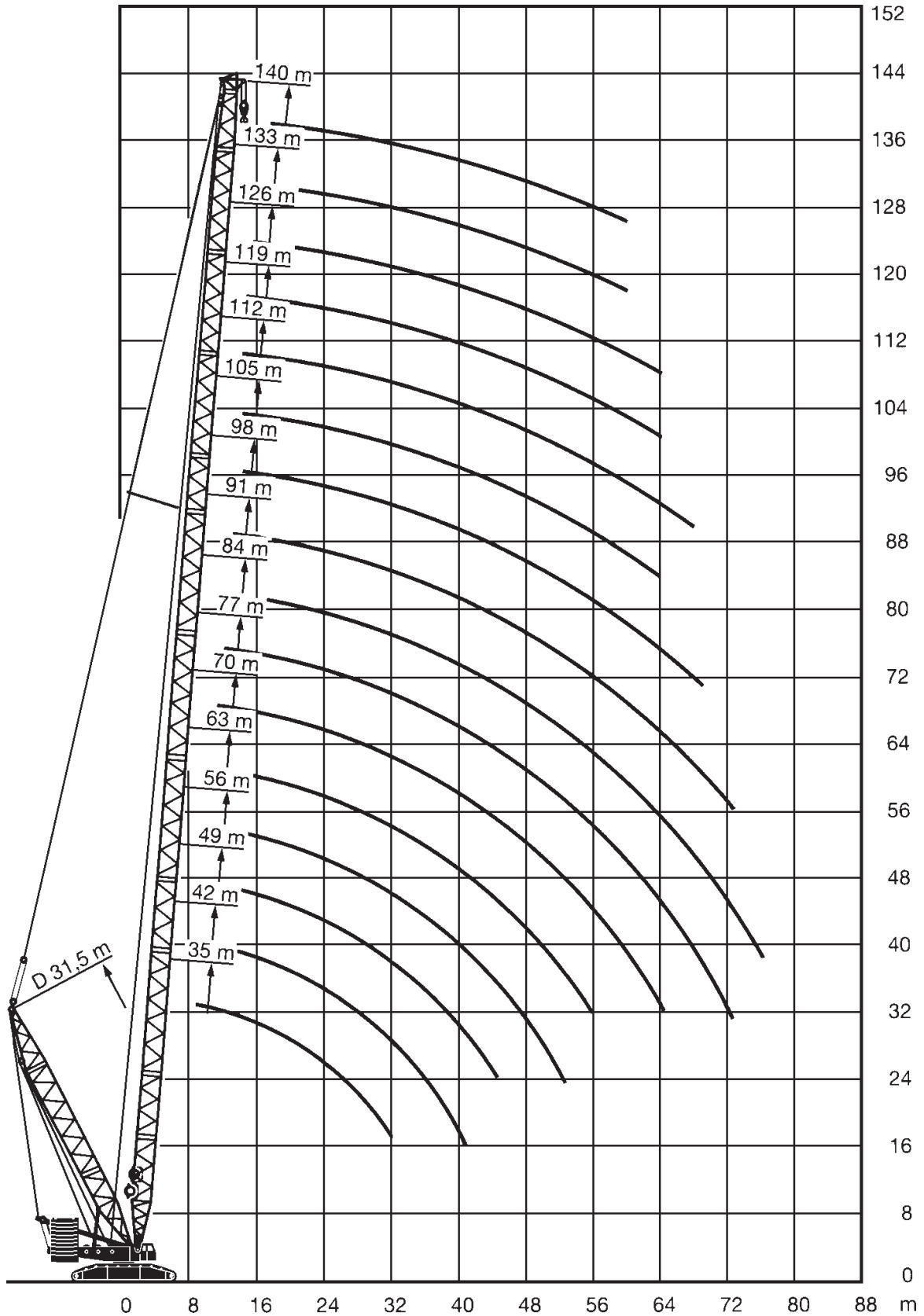

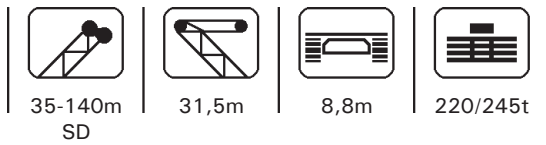

	35	42	49	56	63	70	77*	84*	91*	98*	105*	112*	119*	126*	133*	140*	
7	440																7
8	439	428	422														8
9	431	422	417	391													9
10	399	396	386	376	353	332											10
11	362	370	360	339	319	301	285	269									11
12	341	339	326	307	290	275	261	247	235	224							12
14	286	283	272	259	245	233	222	211	201	192	185	178	167				14
16	241	238	233	222	211	201	192	182	174	167	161	155	149	143	124	105	16
18	209	206	202	193	184	176	168	160	153	147	142	137	131	126	121	105	18
20	182	180	177	170	162	155	148	141	135	130	125	121	117	112	107	104	20
22	160	157	155	152	144	138	132	125	120	115	112	108	104	99	96	93	22
24	143	140	137	134	130	124	118	112	107	103	100	97	93	89	85	83	24
26	129	127	124	122	116	112	106	101	96	92	90	87	83	80	76	74	26
28	117	115	112	111	106	101	96	91	87	83	81	78	75	71	69	66	28
30	106	103	101	100	97	92	87	83	79	75	73	70	68	64	62	60	30
32	97	95	92	91	88	84	79	75	71	68	66	64	61	58	55	53	32
34		87	83	82	81	77	72	68	65	62	60	58	55	52	49,5	48	34
36		80	77	75	73	71	66	62	59	56	54	52	49,5	47	44,5	43	36
38		74	71	68	67	65	59	57	53	51	49	47	45	42	40	38,5	38
40		69	66	61	60	60	53	52	48	46	44,5	42,5	40,5	38	35,5	34,5	40
44			57	54	48	49,5	44,5	43	40	38	36	34,5	32	30	28,2	26,4	44
48				47,5	42,5	38,5	36,5	35	32,5	31	26,8	25,6	23,2	23	21,2	17,6	48
52				41,5	37,5	33	29,2	27,7	25,9	25,1	21,2	18,1	16,5	16,3	14,8	10,3	52
56					32,5	28,5	24,5	20,8	19,7	19,5	16,5	14,6	13,4	10,1	8,8	8	56
60						24,5	21	16,5	13,8	14,2	12,2	11,3	10,5	7,1	5,1	5,4	60
64						20,8	17,7	13,9	9,8	9,3	8,2	8,3	7	5,2			64
68							14,6	11,4	7,8	5,6		5,4					68
72							11,7	9,1	6								72
76								6,9									76

mit 95t Zentralballast

* nur aufrichtbar mit Derrickballast

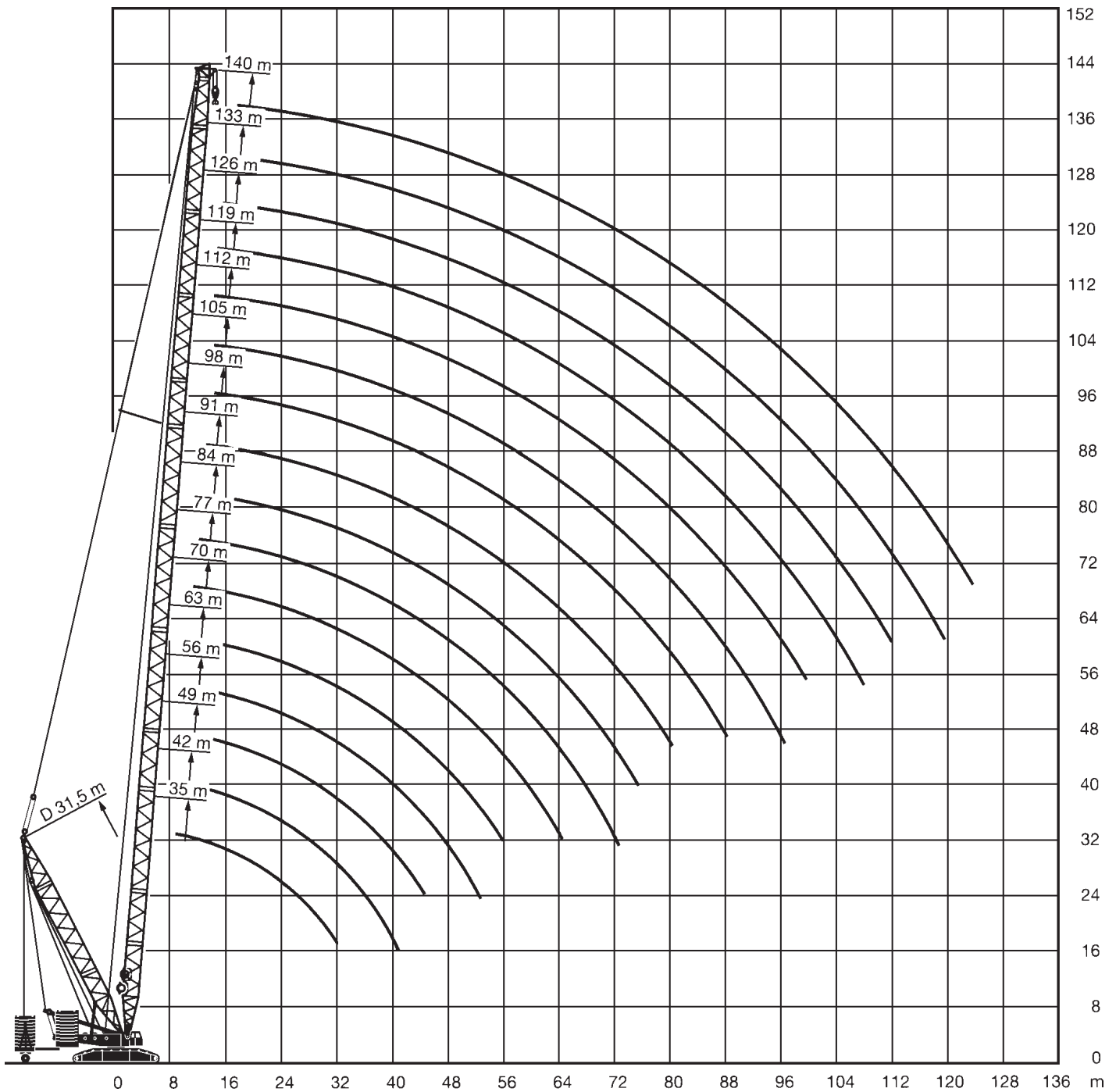

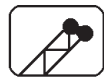
35-140m
SDB/BW

31,5m



8,8m



220t



400t/20m



360°



75%

	35	42	49	56	63	70	77	84	91	98	105	112	119	126	133	140	
7	750																7
8	750	731	713														8
9	715	701	684	665													9
10	687	674	657	643	559	474											10
11	659	649	634	620	558	473	404	346									11
12	635	624	612	581	555	472	403	346	298	258							12
14	576	567	554	537	512	470	402	345	297	257	221	192	167				14
16	541	531	518	499	473	445	401	344	297	256	220	192	167	144	124	105	16
18	512	496	483	464	439	415	387	343	296	256	219	191	166	143	123	105	18
20	458	466	450	432	410	388	364	341	295	255	217	191	166	143	123	104	20
22	402	434	420	403	383	364	342	327	293	254	215	191	165	143	123	104	22
24	357	391	394	377	359	341	323	310	284	252	214	191	165	142	122	103	24
26	315	354	365	357	339	324	305	294	274	247	213	190	164	142	122	103	26
28	281	319	335	336	322	308	288	279	264	239	211	190	164	142	122	102	28
30	249	286	307	311	302	293	274	262	249	232	208	190	164	141	122	102	30
32	220	259	280	288	282	277	258	246	234	223	203	188	163	141	121	101	32
34		235	255	266	264	260	242	231	221	211	197	187	161	140	119	101	34
36		212	234	246	246	244	228	217	208	200	189	185	158	139	117	100	36
38		191	216	226	230	230	213	205	196	189	179	177	156	138	116	99	38
40		171	199	208	214	216	201	195	185	179	170	167	154	137	115	98	40
44			167	181	185	189	181	176	168	161	154	151	147	133	112	96	44
48				156	163	165	163	160	153	147	140	138	133	128	109	94	48
52				134	143	146	146	144	140	135	128	125	122	117	105	92	52
56					125	130	131	130	127	123	118	115	112	107	102	89	56
60						116	118	117	115	113	108	106	103	99	95	86	60
64						102	106	106	104	103	99	98	95	91	88	83	64
68							94	96	95	94	91	90	87	84	81	77	68
72							83	86	86	86	83	82	80	78	75	71	72
76								77	78	78	76	75	73	71	69	65	76
80									70	71	70	69	64	65	63	60	80
84									63	64	64	63	60	60	58	55	84
88										58	58	57	55	55	53	51	88
92											52	52	50	50	48,5	46,5	92
96											46,5	46,5	46	45	41,5	42	96
100												41,5	41	41	37,5	38	100
104													36,5	36,5	34	34	104
108													32	32,5	30,5	30,5	108
112														28,4	27	26,8	112
116															23,6	23,3	116
120															20	19,9	120
124																16,6	124

mit 95t Zentralballast

Traglasten über 600t nur mit Zusatzausrüstung

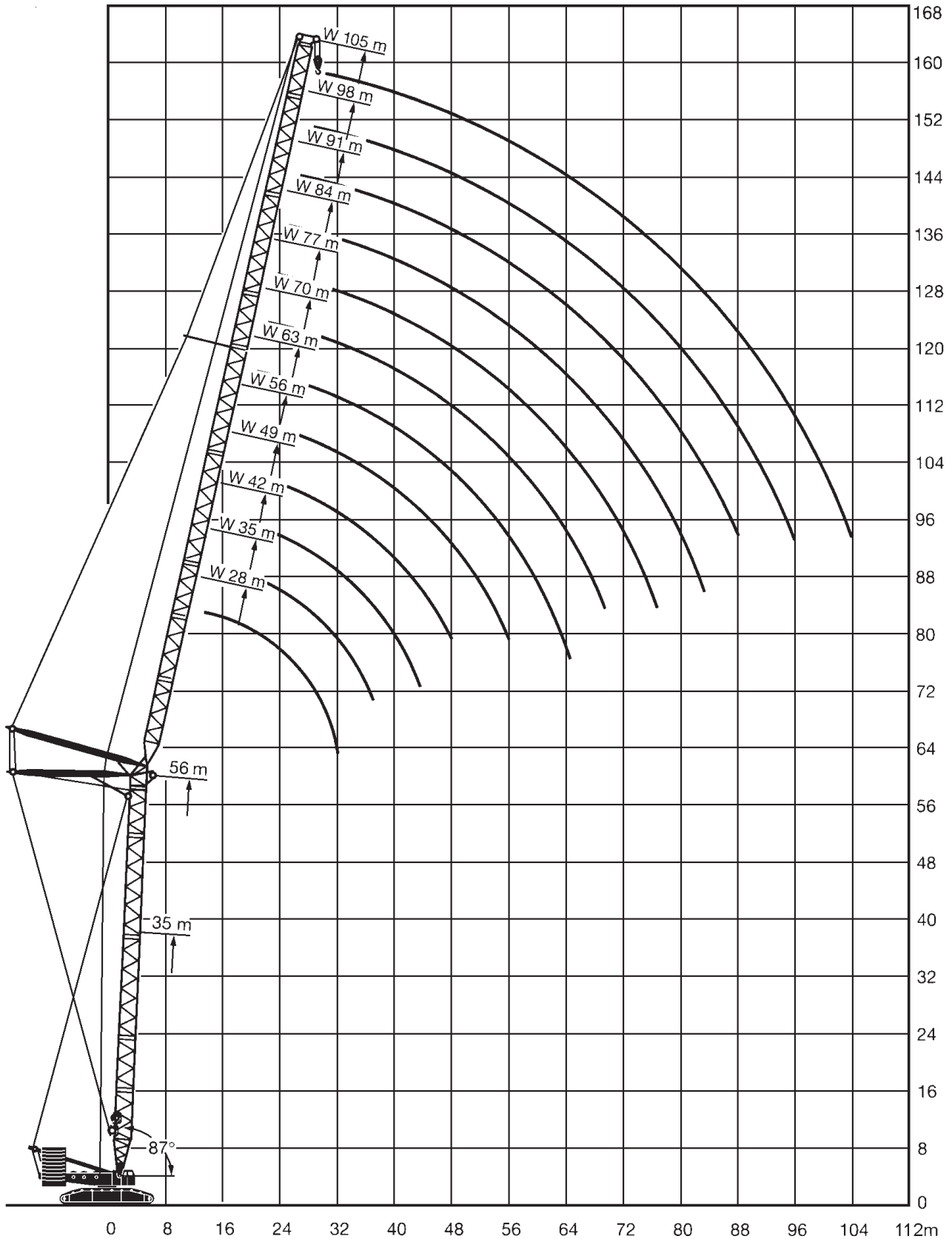

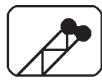
35m
SW 87°

28-105m

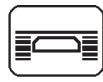

8,8m



245t



360°



75%

	35												
	28	35	42	49	56	63	70	77	84	91	98	105	
14	258												14
16	226	216	208										16
18	200	192	185	178									18
20	180	172	166	160	155								20
22	163	156	151	145	141	136							22
24	149	143	138	133	129	124	120	106					24
26	137	131	127	122	119	114	110	105	89				26
28	126	121	117	113	110	106	102	99	88	74			28
30	115	113	109	105	102	98	94	92	87	74	62		30
32		105	101	98	95	91	88	85	83	73	61	52	32
34		97	95	91	89	85	82	79	77	73	61	52	34
36		90	89	85	83	80	76	74	72	70	60	51	36
38			83	80	78	75	72	70	68	65	59	51	38
40			77	76	73	70	67	65	64	61	59	50	40
44			68	67	66	63	60	58	56	54	53	49,5	44
48				59	59	56	53	52	50	48	46,5	44,5	48
52					52	51	48	46,5	45	42,5	41,5	39,5	52
56					47	46	43	41,5	40	38	37	35	56
60						41	39	37,5	36	34	33	31	60
64						37	35,5	34	32,5	30,5	29,6	27,7	64
68							32,5	31	29,5	27,5	26,5	24,6	68
72								28,2	26,7	24,8	23,7	21,9	72
76								25,8	24,2	22,3	21,2	19,4	76
80									22	20,1	19	17,2	80
84										18,1	16,9	15,2	84
88										16,3	15,1	13,3	88
92											13,4	11,7	92
96											12	10,2	96
100												8,2	100

mit 95t Zentralballast



	42												
	28	35	42	49	56	63	70	77	84	91	98	105	
14	244												14
16	215	206											16
18	191	183	177	170									18
20	172	165	160	154	148								20
22	156	150	145	140	135	130							22
24	142	137	133	128	124	119	115						24
26	131	126	122	118	114	110	106	98					26
28	122	117	113	109	105	101	98	95	82	70			28
30	113	109	105	101	98	94	91	88	81	69	59		30
32		101	98	94	91	88	85	82	79	68	58	49	32
34		95	92	88	85	82	79	76	74	68	57	48,5	34
36		89	86	83	80	77	74	71	69	67	57	48	36
38		83	81	78	75	72	70	67	65	62	56	47,5	38
40			77	73	71	68	65	63	61	58	56	47	40
44			68	66	63	60	58	56	54	52	50	46,5	44
48				59	57	54	52	49,5	48	45,5	44,5	42,5	48
52					51	48,5	46,5	44,5	43	40,5	39,5	37,5	52
56					46,5	44	42	40	38,5	36,5	35	33	56
60						40	38	36	34,5	32,5	31,5	29,5	60
64						37	34,5	32,5	31	29,1	28,1	26,2	64
68							31,5	29,4	28	26,1	25,1	23,2	68
72								26,7	25,3	23,4	22,4	20,6	72
76								24,4	22,9	21	20	18,2	76
80									20,8	18,8	17,8	16	80
84									18,9	16,9	15,8	14	84
88										15,2	14	12,3	88
92											12,4	10,6	92
96											11	9	96
100												7,1	100

mit 95t Zentralballast

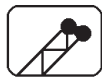

49m
SW 87°



28-105m



8,8m



245t



360°



75%

	49												
	28	35	42	49	56	63	70	77	84	91	98	105	
14	232												14
16	204	196											16
18	182	175	169										18
20	164	158	152	148									20
22	149	144	139	135	130	124							22
24	137	132	127	123	119	114	105						24
26	126	121	117	114	110	105	102	91					26
28	117	112	108	105	102	97	94	89	76				28
30	109	105	101	98	95	90	87	85	75	64	54		30
32		98	94	91	88	84	81	79	75	63	54	45,5	32
34		92	88	85	82	78	76	74	71	63	53	45	34
36		86	83	80	77	73	71	69	66	62	53	44,5	36
38		82	78	75	73	69	67	65	62	59	52	44	38
40			74	71	68	65	63	61	58	56	52	44	40
44			66	64	61	58	56	54	51	49	48	43	44
48				58	55	52	49,5	48	46	43,5	42,5	40	48
52					50	46,5	44,5	43	41	38,5	37,5	35,5	52
56					45,5	42	40	38,5	36,5	34,5	33,5	31,5	56
60						38	36,5	35	33	30,5	29,7	27,8	60
64						35	33	31,5	29,4	27,4	26,5	24,6	64
68							30	28,6	26,5	24,5	23,6	21,7	68
72								26	23,9	21,9	21	19,2	72
76								23,7	21,5	19,6	18,6	16,8	76
80									19,5	17,5	16,5	14,7	80
84									17,7	15,6	14,6	12,8	84
88										14	12,9	11,1	88
92											11,3	9,5	92
96											9,9	7,4	96
100												6,3	100
104												5,3	104

mit 95t Zentralballast



56m
SW 87°



28-105m



8,8m



245t



360°



DIN
75%

	56												
	28	35	42	49	56	63	70	77	84	91	98	105	
16	194	187											16
18	174	168	161										18
20	157	152	146	141									20
22	143	138	133	128	124								22
24	131	127	122	118	114	110	99						24
26	121	117	113	109	105	101	97	83					26
28	112	108	105	101	97	94	90	82	70				28
30	105	101	97	94	90	87	83	81	69	60			30
32	98	94	91	87	84	81	78	76	68	60	50		32
34		88	85	82	79	76	73	71	68	59	49,5	41,5	34
36		83	80	77	74	71	68	66	63	59	49	41,5	36
38		79	75	72	70	67	64	62	59	58	48,5	41	38
40			71	68	66	63	60	58	56	54	48	41	40
44			64	61	59	56	53	52	49	48	45,5	40	44
48				55	53	50	47,5	46	43,5	42,5	40	38	48
52					47,5	45	42,5	41	39	37,5	35,5	33,5	52
56					43,5	40,5	38	37	34,5	33,5	31,5	29,6	56
60						37	34,5	33	31	30	28	26,1	60
64						34	31	29,9	27,8	26,8	24,9	23	64
68							28,4	27	24,9	24	22,1	20,2	68
72								24,5	22,4	21,4	19,6	17,7	72
76								22,2	20,1	19,1	17,3	15,5	76
80									18,1	17,1	15,2	13,5	80
84									16,4	15,2	13,4	11,6	84
88										13,5	11,7	9,9	88
92											10,2	7,6	92
96											8,8	6,4	96
100												5,4	100
104												4,4	104

mit 95t Zentralballast

63m
SW 87°

28-56m



8,8m



245t



360°



75%

	28	35	63 42	49	56	
16	186					16
18	167	160	154			18
20	151	145	140	135		20
22	138	132	128	123	119	22
24	126	121	117	113	109	24
26	117	112	108	104	101	26
28	108	104	100	97	94	28
30	101	97	94	90	87	30
32	95	91	87	84	81	32
34		85	82	79	76	34
36		80	77	74	71	36
38		76	73	70	67	38
40			69	66	63	40
44			62	59	57	44
48				53	51	48
52				48,5	46	52
56					42	56

mit 95t Zentralballast

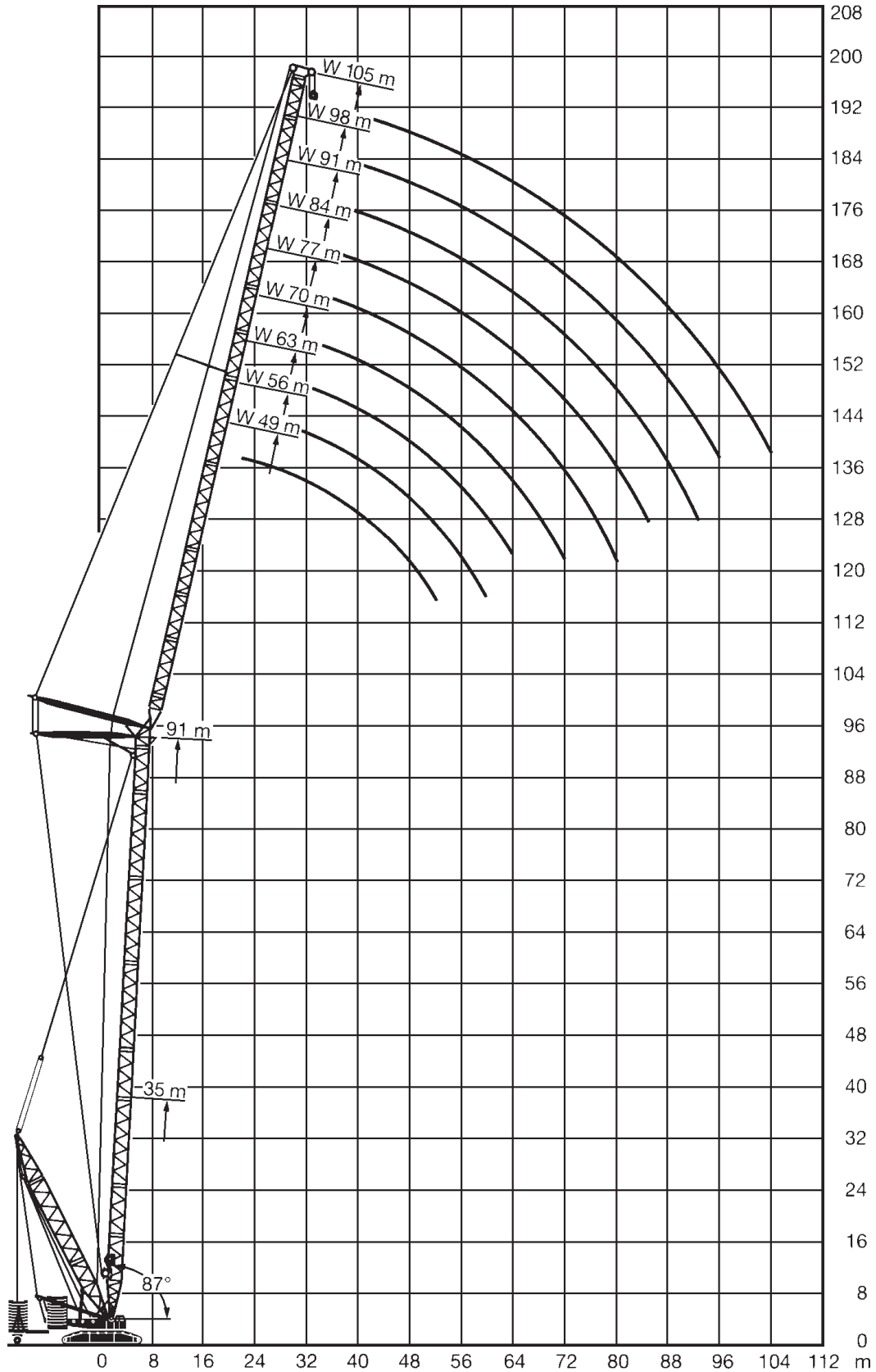

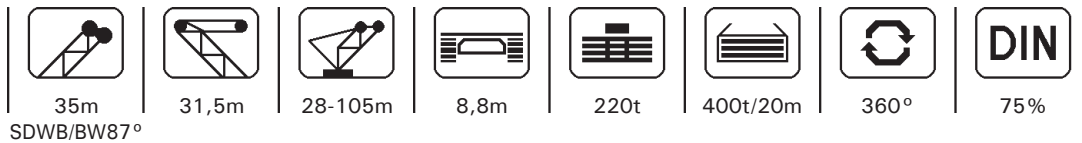

	35												
	28	35	42	49	56	63	70	77	84	91	98	105	
14	380												14
16	372	315											16
18	363	306	258										18
20	349	298	252	211	178								20
22	337	290	247	207	174	148							22
24	312	281	242	203	171	146	127						24
26	283	272	236	200	168	144	125	105					26
28	256	254	230	197	166	142	124	104	88				28
30	222	233	224	193	163	140	122	104	87	74	61		30
32		216	214	190	161	138	121	103	86	74	60	52	32
34		196	197	186	158	136	120	102	85	73	59	52	34
36		174	184	183	156	134	119	101	85	73	59	51	36
38			172	169	154	132	117	100	84	72	58	51	38
40			157	160	152	131	116	100	83	71	58	50	40
44			125	142	139	127	113	97	82	70	57	49,5	44
48				120	125	123	110	95	80	68	56	48,5	48
52					108	111	108	93	79	66	55	47,5	52
56					90	99	99	91	78	65	54	46,5	56
60						85	90	88	77	63	53	45,5	60
64						70	79	81	75	62	52	44,5	64
68							68	73	73	60	51	43,5	68
72								65	68	59	50	42,5	72
76								55	60	58	50	41,5	76
80									52	56	49,5	41	80
84										49,5	49,5	40,5	84
88										42,5	45,5	40	88
92											39,5	39,5	92
96											33,5	36,5	96
100												31	100

mit 95t Zentralballast

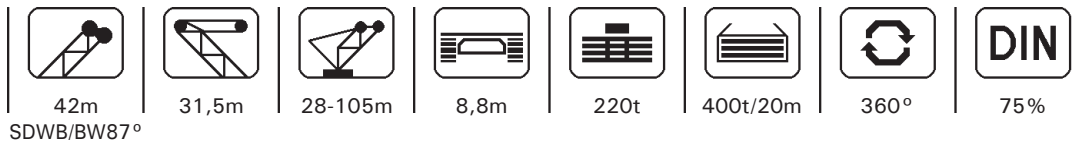

	42												
	28	35	42	49	56	63	70	77	84	91	98	105	
14	355												14
16	344	290											16
18	334	282	236										18
20	323	275	231	195									20
22	312	268	226	191	160	139							22
24	302	260	221	188	158	137	118						24
26	290	253	216	185	156	136	116	99					26
28	266	246	211	182	154	134	114	98	82				28
30	232	238	206	178	153	132	113	97	81	70			30
32		224	202	175	150	131	111	96	80	69	58		32
34		203	198	171	147	129	110	95	80	68	57	49	34
36		181	190	168	144	127	109	94	79	68	57	48,5	36
38		157	177	165	142	126	108	94	78	67	56	48	38
40			162	162	140	124	106	93	78	67	55	47,5	40
44			130	147	135	121	104	91	77	66	54	46,5	44
48				125	128	119	102	89	75	64	53	46	48
52					111	114	101	87	74	63	52	45,5	52
56					93	102	98	85	73	62	51	44,5	56
60						88	93	84	72	60	50	43,5	60
64						74	82	82	71	59	49	42,5	64
68							71	76	69	58	48	41,5	68
72								67	68	57	47,5	41	72
76								57	62	56	47	40	76
80									54	55	46	39,5	80
84									45,5	51	45,5	39	84
88										44	45,5	38	88
92											42	38	92
96											35,5	37,5	96
100												33	100

mit 95t Zentralballast

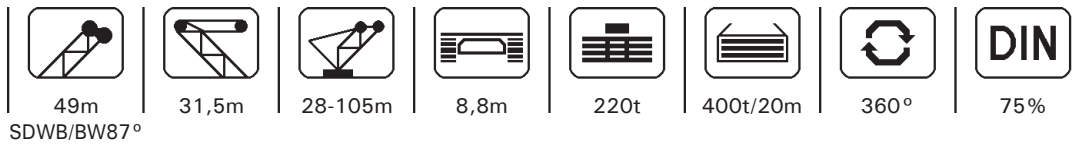

	49												
	28	35	42	49	56	63	70	77	84	91	98	105	
14	324												14
16	313	263											16
18	304	256	215										18
20	295	250	211	179									20
22	285	243	207	176	150								22
24	277	236	203	173	148	126							24
26	268	230	199	170	146	125	106	92					26
28	259	224	194	168	144	124	105	91	77				28
30	242	218	190	164	142	123	104	90	77	66			30
32		214	186	161	140	122	103	89	76	65	55		32
34		208	183	158	137	121	102	88	75	64	54	45,5	34
36		188	178	155	135	119	102	87	74	64	53	45	36
38		164	174	153	133	116	101	87	74	63	53	44,5	38
40			167	150	130	115	99	86	73	63	52	44	40
44			136	144	127	111	96	84	72	62	52	43,5	44
48				128	123	108	94	83	70	61	51	42,5	48
52					114	105	91	81	69	60	49,5	42	52
56					97	102	89	80	68	59	48,5	41,5	56
60						90	87	78	67	58	47,5	40,5	60
64						76	84	76	66	56	46,5	40	64
68							73	74	65	55	46	39	68
72								68	63	55	45	38,5	72
76								59	63	54	44,5	38	76
80									55	53	43,5	37,5	80
84									47	52	43,5	37	84
88										45	43	36,5	88
92											42,5	36	92
96												37	96
100													100
104													104

mit 95t Zentralballast

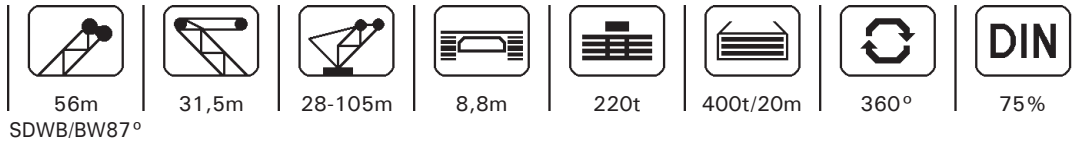

	56												
	28	35	42	49	56	63	70	77	84	91	98	105	
16	283												16
18	275	231	196										18
20	267	225	192	162									20
22	258	220	189	159	138								22
24	249	214	185	157	135	117							24
26	241	209	181	155	133	116	98						26
28	235	204	177	153	131	114	97	84	71				28
30	231	199	173	150	129	112	96	83	71	60			30
32	208	194	169	146	127	111	94	83	70	60	51		32
34		189	165	143	125	109	93	82	69	59	50	42	34
36		186	162	140	124	108	92	82	69	59	49,5	42	36
38		165	158	138	122	106	91	81	68	58	49	41,5	38
40			156	135	120	105	90	80	68	58	48,5	41,5	40
44			137	130	117	103	88	78	67	57	48	40,5	44
48				127	112	101	86	76	65	56	47	40	48
52					109	97	84	75	64	55	46	39,5	52
56					94	94	82	73	63	54	45	38,5	56
60						89	81	71	62	54	44	38	60
64						75	80	70	61	53	43	37	64
68							71	69	60	52	42,5	36,5	68
72								67	59	51	41,5	36	72
76								57	58	50	41	35,5	76
80									55	49,5	40,5	35	80
84									46,5	49	40,5	34,5	84
88										43,5	40	34,5	88
92											40	34,5	92
96											36	34	96
100												33,5	100
104												27,7	104

mit 95t Zentralballast

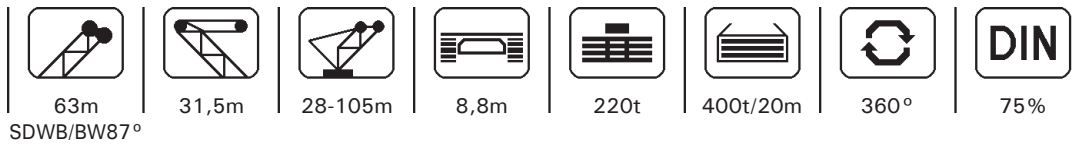

	63												
	28	35	42	49	56	63	70	77	84	91	98	105	
16	250												16
18	243	207											18
20	236	202	175	150									20
22	227	198	171	147	125								22
24	219	193	168	145	124	106							24
26	213	188	164	143	122	105	92						26
28	207	184	161	141	121	104	91	78					28
30	203	180	157	139	120	103	90	77	65				30
32	202	175	154	135	118	102	89	77	65	56	46,5		32
34		170	151	133	116	101	88	76	64	56	46	39,5	34
36		166	148	130	114	100	87	75	63	55	46	39,5	36
38		165	145	127	111	98	86	74	63	55	45,5	39	38
40			143	125	109	96	85	73	62	55	45	38,5	40
44			140	122	105	93	83	72	61	54	44	38	44
48				119	103	90	81	70	60	53	43,5	37,5	48
52				107	101	87	79	69	59	52	42,5	36,5	52
56					99	85	77	67	57	51	41,5	36	56
60						84	75	66	56	50	40,5	35	60
64						78	73	64	55	49	39,5	34,5	64
68							73	63	54	48,5	39	34	68
72							62	62	53	47,5	38	33	72
76								61	53	46,5	37,5	32,5	76
80									53	46	37	32	80
84									48,5	45,5	36,5	32	84
88										45,5	36	31,5	88
92											36	31,5	92
96											36	31,5	96
100												31,5	100
104												30,5	104

mit 95t Zentralballast

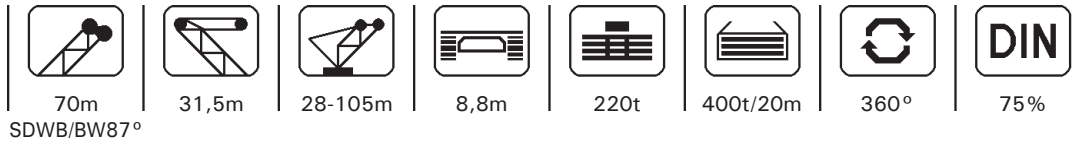

	70												
	28	35	42	49	56	63	70	77	84	91	98	105	
16	217												16
18	212	183											18
20	207	179	157										20
22	200	175	154	134									22
24	192	171	150	131	113	99							24
26	186	166	147	129	111	98	84						26
28	182	160	143	126	109	96	83	71					28
30	179	156	139	124	107	95	82	70	60				30
32	177	152	136	121	105	94	81	69	59	52			32
34		149	132	118	104	93	80	69	58	51	42		34
36		147	129	115	102	92	79	68	58	51	42	35,5	36
38		146	127	113	101	90	79	68	57	50	41,5	35,5	38
40			125	110	99	89	77	67	56	50	41,5	35	40
44			122	107	95	86	75	66	55	49	40,5	34,5	44
48				104	92	83	73	64	54	48,5	40	34	48
52				103	89	81	72	63	53	47,5	39,5	33,5	52
56					87	78	70	61	52	46,5	38,5	33	56
60						76	68	60	51	45,5	37,5	32,5	60
64						75	66	59	51	45	36,5	31,5	64
68							65	57	50	44	35,5	31	68
72							64	56	49	43	35	30,5	72
76								55	48	42,5	34,5	29,8	76
80									47,5	41,5	34	29,4	80
84									47	41	33	29	84
88										41	32,5	28,6	88
92										40,5	32,5	28,3	92
96											32,5	28	96
100												28	100
104												28	104

mit 95t Zentralballast

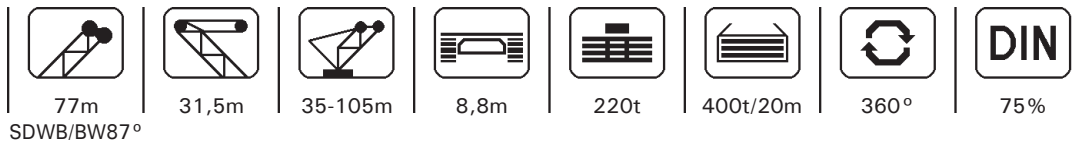

	77											
	35	42	49	56	63	70	77	84	91	98	105	
18	163											18
20	159	139										20
22	155	136	121									22
24	151	132	118	103								24
26	147	130	116	101	88							26
28	143	126	114	100	87	76	64					28
30	139	123	111	98	86	75	63	55				30
32	136	120	109	97	85	74	63	55	46,5			32
34	132	117	106	95	83	73	63	54	46	35		34
36	129	114	104	92	82	72	62	54	46	35	29,2	36
38	128	112	101	90	81	71	61	53	45,5	34,5	29	38
40		110	99	88	79	70	61	53	45,5	34	28,8	40
44		106	95	85	76	68	60	52	44,5	33,5	28,3	44
48			92	82	73	66	58	51	44	33	28	48
52			91	79	71	63	56	49,5	43	32,5	27,6	52
56				78	68	61	54	48	42	31,5	27	56
60					66	59	52	47	41	30,5	26,3	60
64					66	58	51	46	40	29,8	25,7	64
68						57	49,5	44,5	39	29,1	25,1	68
72						56	48,5	43,5	38	28,4	24,5	72
76							48	42,5	37	28	24	76
80								41,5	36	27,6	23,6	80
84								41,5	35,5	27,2	23,3	84
88									35	26,8	22,9	88
92									34,5	26,7	22,7	92
96										26,7	22,3	96
100											22,1	100
104											21,9	104

mit 95t Zentralballast

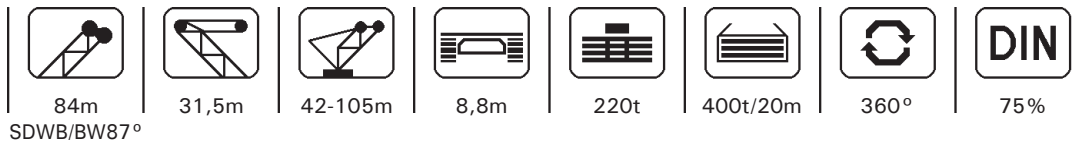

	84										
	42	49	56	63	70	77	84	91	98	105	
20	125										20
22	122	107									22
24	119	105	92								24
26	116	103	91	79							26
28	113	101	89	78	68						28
30	110	99	88	77	67	59	49,5				30
32	107	96	86	75	66	58	49	37,5			32
34	104	93	84	74	65	58	48,5	37	31		34
36	102	91	82	73	64	57	48	36,5	31	24,5	36
38	99	89	80	71	63	56	47,5	36,5	30,5	24,3	38
40	97	87	78	70	62	56	47,5	36	30,5	24,1	40
44	94	83	75	67	59	54	46,5	35,5	29,8	23,7	44
48		81	72	64	57	52	45,5	35	29,2	23,3	48
52		79	69	62	54	50	43,5	34,5	28,7	23	52
56			68	60	53	48	42	33	28	22,6	56
60			67	58	51	46	41	32	27,2	22,1	60
64				57	50	45	39,5	30,5	26,5	21,5	64
68					48,5	43,5	38	29,7	25,8	20,9	68
72					48	42	37	28,8	25,1	20,3	72
76						41,5	36	28	24,6	19,8	76
80							35	27,2	23,9	19,1	80
84							34,5	26,5	23,3	18,5	84
88								26	22,7	17,9	88
92								25,6	22,2	17,4	92
96									21,8	16,9	96
100										16,6	100
104										16,3	104

mit 95t Zentralballast

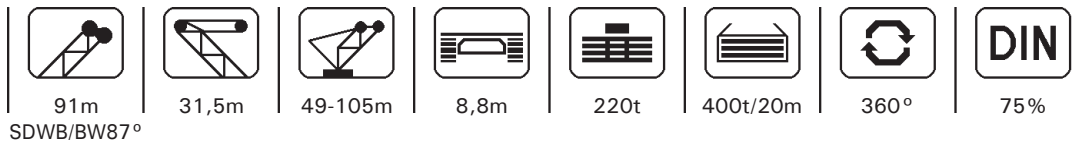

	49	56	63	70	91 77	84	91	98	105	
22	94									22
24	92	81								24
26	91	79	70							26
28	89	78	69	60						28
30	87	76	67	59	52					30
32	85	75	66	58	51	39				32
34	82	74	65	57	50	38,5	33,5	26,1		34
36	80	72	64	56	49,5	38,5	33	25,8	20	36
38	78	70	63	55	49	38	33	25,5	19,8	38
40	76	68	61	55	48	37,5	32,5	25,3	19,6	40
44	73	65	58	52	46,5	36,5	32	24,8	19,2	44
48	71	62	55	49,5	44,5	35,5	31,5	24,3	18,8	48
52	69	60	53	47,5	42,5	33,5	30	23,9	18,5	52
56		58	52	45,5	41	32,5	28,8	23,3	18,2	56
60		57	50	44	39,5	31	27,6	22,4	17,7	60
64			49	42,5	38	29,7	26,5	21,5	16,9	64
68				41,5	37	28,7	25,5	20,6	16,2	68
72				41	35,5	27,8	24,6	19,8	15,6	72
76					35	26,9	23,8	19,1	14,9	76
80					34,5	26,2	23,1	18,4	14,3	80
84						25,7	22,4	17,7	13,7	84
88							21,8	17,1	13,2	88
92							21,3	16,6	12,7	92
96								16,2	12,2	96
100									11,8	100
104									11,5	104

mit 95t Zentralballast

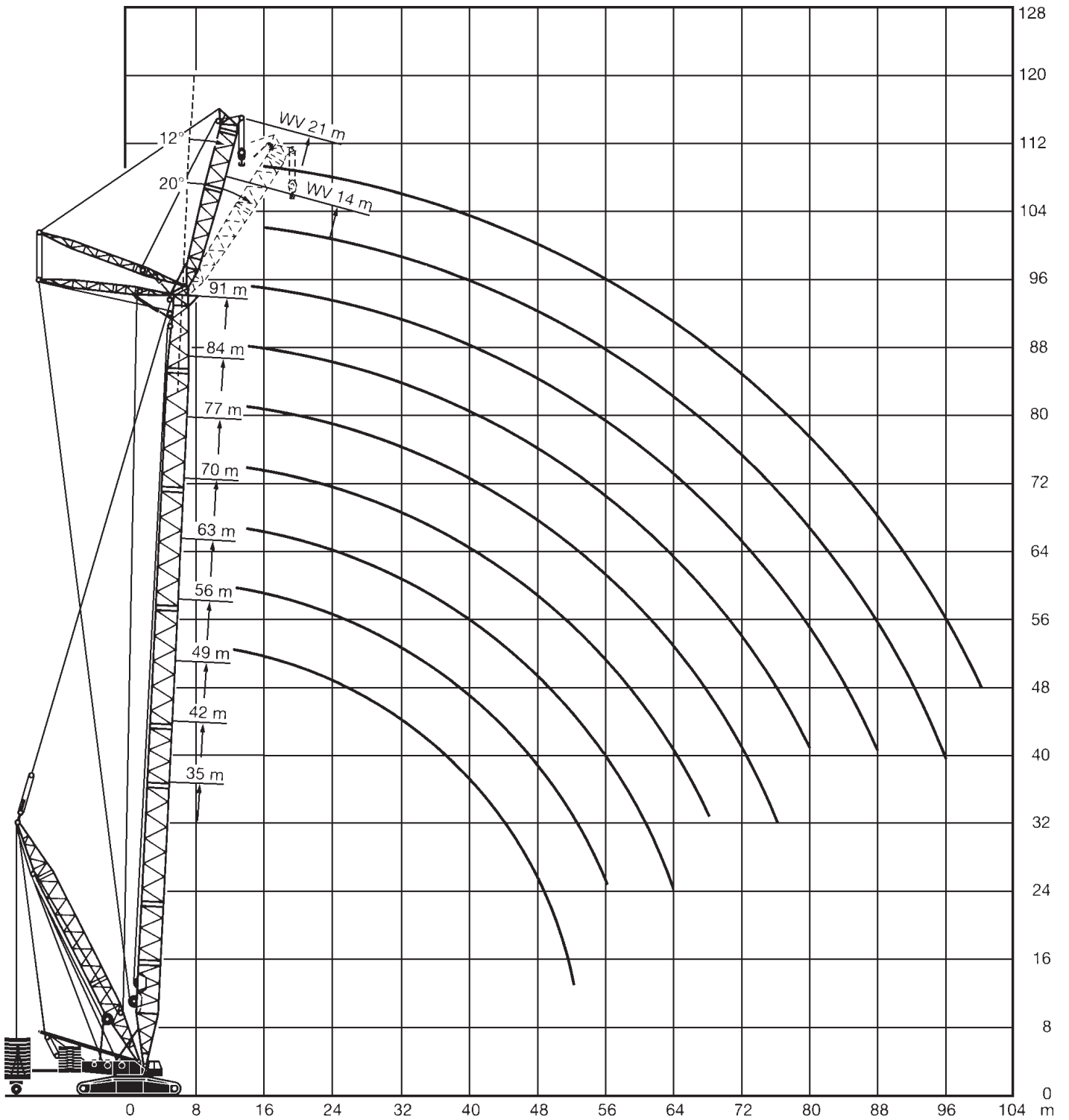



35-70m
SDVV



31,5m



14m



8,8m



220/245t



360°



75%

	12°						20°						
	35	42	49*	56*	63*	70*	35	42	49*	56*	63*	70*	
10	343	338											10
11	343	328	317	315	298								11
12	316	312	302	287	272	259	322	303					12
14	282	266	253	241	230	219	287	272	259	247	235	225	14
16	228	227	216	206	197	188	235	231	221	211	202	193	16
18	197	192	187	179	171	163	196	195	191	183	175	168	18
20	169	167	163	156	149	143	171	168	165	160	153	147	20
22	145	145	144	138	131	126	148	147	145	141	135	129	22
24	128	125	126	122	116	111	128	128	128	125	119	114	24
26	115	109	108	109	103	98	115	111	112	111	106	101	26
28	103	99	94	95	92	88	103	99	97	98	95	90	28
30	92	89	85	82	81	78	93	89	86	85	84	81	30
32	82	80	77	74	70	70	83	81	77	74	73	72	32
34	73	71	69	67	63	60	74	72	70	67	63	63	34
36	64	63	62	60	57	53	65	65	63	60	57	54	36
38	59	56	55	53	51	48	59	57	56	54	52	48,5	38
40	55	49	48,5	47,5	45,5	43	55	50	49,5	48	46	44	40
44	46,5	41	36,5	36	35,5	34,5	46,5	41,5	37,5	37	36,5	35	44
48		34,5	30,5	25,7	26	26,1		34,5	30,5	26,9	27,2	27	48
52		28,2	25,3	20,9	17,3	18,6		28,3	25,3	20,9	18,8	19,8	52
56			20,6	17,1	13,3	11,5			20,6	17	13,5	12,7	56
60				13,5	10,2	8,4				13,5	10,3	8,4	60
64				10,1	7,4	4,8				10,1	7,4	5,4	64
68					4,5						4,7		68

mit 95t Zentralballast

*nur aufrichtbar mit Derrickballast

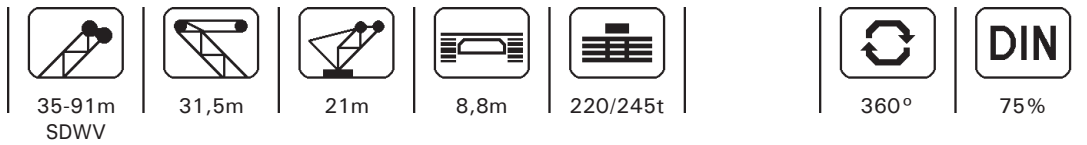

	12°									20°									
	35	42	49*	56*	63*	70*	77*	84*	91*	35	42	49*	56*	63*	70*	77*	84*	91*	
12	305	295																	12
14	275	260	248	236	226	216	206												14
16	235	223	212	203	194	186	178	170	162	240	229	219	210	201					16
18	197	193	185	177	169	162	155	148	141	207	199	190	183	175	169	162	155	148	18
20	171	167	162	155	148	143	136	130	124	174	174	167	160	154	148	142	136	130	20
22	150	147	143	137	131	126	120	114	109	151	149	148	142	136	131	125	120	115	22
24	132	130	127	122	116	112	106	101	96	134	132	129	126	121	116	111	106	101	24
26	114	114	113	109	104	99	94	90	85	119	117	115	113	108	104	99	94	90	26
28	103	99	99	98	93	89	84	79	75	104	104	103	101	97	93	88	84	80	28
30	93	89	87	87	83	79	75	71	66	94	91	91	90	87	83	79	75	71	30
32	85	81	77	76	75	71	67	63	59	85	81	80	80	78	75	70	67	63	32
34	77	73	70	66	65	64	60	56	52	78	74	70	70	69	67	63	59	56	34
36	69	66	63	60	56	56	53	49,5	45,5	70	67	64	61	60	60	56	53	49	36
38	62	60	57	54	51	48	46,5	43,5	40	63	61	58	55	52	52	50	46,5	43	38
40	55	53	51	49	46,5	43	39	37	35	57	55	52	50	47,5	44,5	42,5	41	38	40
44	46	41,5	40,5	39	37,5	35,5	31	25,5	22,3	46	43,5	42	40,5	38,5	36	31,5	27,7	27,3	44
48	39,5	34,5	30,5	29,9	29,5	28,1	24,7	19,6	15,6	39,5	34,5	32	31,5	31	29,1	25,4	20,5	17	48
52	33	29,3	24,2	21,5	22,1	21,6	18	14,1	11,3	33,5	29,4	24,3	23,5	23,6	22,7	19,8	15,3	12,6	52
56		24,5	20,3	16,2	15,1	15,5	12,3	9,1	5,9		24,7	20,3	16,6	16,9	16,7	13,9	10,5	7,9	56
60			16,6	13,2	10,6	9,8	7,2				20,3	16,7	13,5	10,9	11,2	8,7	5,7		60
64			13,2	10,4	8,1	6,1						13,3	10,6	8,4	6,2				64
68				7,8	5,4								7,9	6,1					68
72													5,4						72

mit 95t Zentralballast

*nur aufrichtbar mit Derrickballast

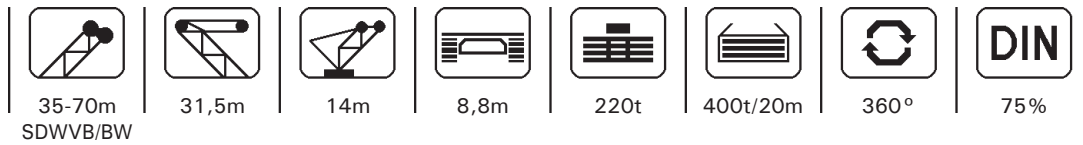

	12°						20°						
	35	42	49	56	63	70	35	42	49	56	63	70	
10	590	580											10
11	590	580	511	436	373								11
12	590	580	511	435	372	320	526	534					12
14	551	541	511	435	372	320	489	499	491	421	361	310	14
16	512	503	486	435	372	319	456	470	478	421	361	310	16
18	476	468	453	435	371	319	428	443	450	421	361	310	18
20	444	436	423	409	371	318	404	420	423	406	361	310	20
22	407	405	396	384	367	318	382	400	397	384	361	310	22
24	373	369	367	361	347	318	362	372	368	361	348	310	24
26	341	339	336	333	326	315	341	340	339	334	328	308	26
28	310	318	310	307	303	292	311	317	312	310	305	288	28
30	281	298	292	284	281	270	283	297	290	287	282	268	30
32	254	276	275	268	259	250	257	277	274	267	260	250	32
34	228	253	258	253	243	231	232	255	258	253	241	232	34
36	205	231	240	238	228	217	209	233	240	237	227	216	36
38	187	210	222	222	215	204	189	213	223	222	214	204	38
40	171	191	205	208	202	194	173	194	207	208	202	193	40
44	141	163	173	180	179	173	143	164	176	181	179	173	44
48		138	150	155	157	154		139	151	157	158	154	48
52		115	129	136	137	137		115	130	137	139	138	52
56			110	119	121	121			111	120	122	122	56
60				103	107	107				104	108	108	60
64				88	94	96				89	94	96	64
68					81	84					82	85	68
72						74						74	72
76						64						64	76

mit 95t Zentralballast

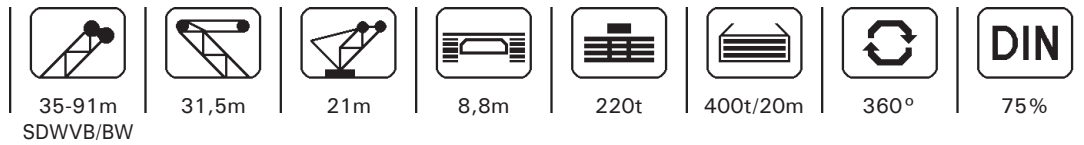

	12°									20°									
	35	42	49	56	63	70	77	84	91	35	42	49	56	63	70	77	84	91	
12	504	460																	12
14	500	459	413	361	311	269	233												14
16	498	457	413	361	311	269	232	202	174	426	430	392	343	298					16
18	471	456	413	361	311	269	232	200	172	398	407	392	343	298	259	225	195	170	18
20	435	423	411	361	311	269	231	199	171	373	385	392	343	298	259	225	194	168	20
22	401	395	384	361	311	268	230	198	169	352	364	375	343	298	259	224	193	167	22
24	367	364	358	349	311	267	229	196	168	334	347	356	343	298	259	223	192	166	24
26	336	335	332	326	311	266	227	195	167	317	331	331	324	298	259	223	191	164	26
28	312	309	307	303	301	266	226	194	166	301	312	309	303	295	259	222	190	163	28
30	288	288	284	282	280	266	225	192	164	287	290	288	284	277	259	221	189	162	30
32	265	272	266	263	260	248	223	191	162	266	271	268	266	259	245	221	188	161	32
34	243	257	252	246	241	232	220	189	160	245	257	251	248	242	230	217	186	158	34
36	222	240	239	234	224	216	206	188	158	226	241	238	233	225	216	204	184	156	36
38	203	222	226	221	211	201	193	183	156	207	224	226	220	210	202	192	182	154	38
40	184	205	211	208	200	190	180	172	154	189	208	211	207	199	190	181	172	152	40
44	155	173	183	184	179	171	162	152	145	158	177	185	184	178	170	161	153	145	44
48	131	148	158	162	160	154	147	138	130	133	151	161	163	160	154	146	138	129	48
52	109	128	137	141	142	139	133	126	118	111	130	139	143	143	139	132	125	118	52
56		109	119	124	125	124	120	114	108		110	121	126	127	125	120	114	107	56
60			103	110	111	111	108	103	98		92	105	111	112	112	108	103	98	60
64			88	96	99	98	96	93	88			89	97	100	99	97	94	89	64
68				83	87	88	86	83	80				84	88	89	87	84	80	68
72					76	78	77	74	71				72	77	79	78	75	72	72
76					66	69	69	67	64					67	70	69	67	64	76
80						60	61	59	57						61	61	60	57	80
84							53	53	50						52	54	53	51	84
88							46	46	44							46,5	46,5	44,5	88
92								40	38,5								40	39	92
96								33,5	33								34	33	96
100									27,4									27,6	100

mit 95t Zentralballast